

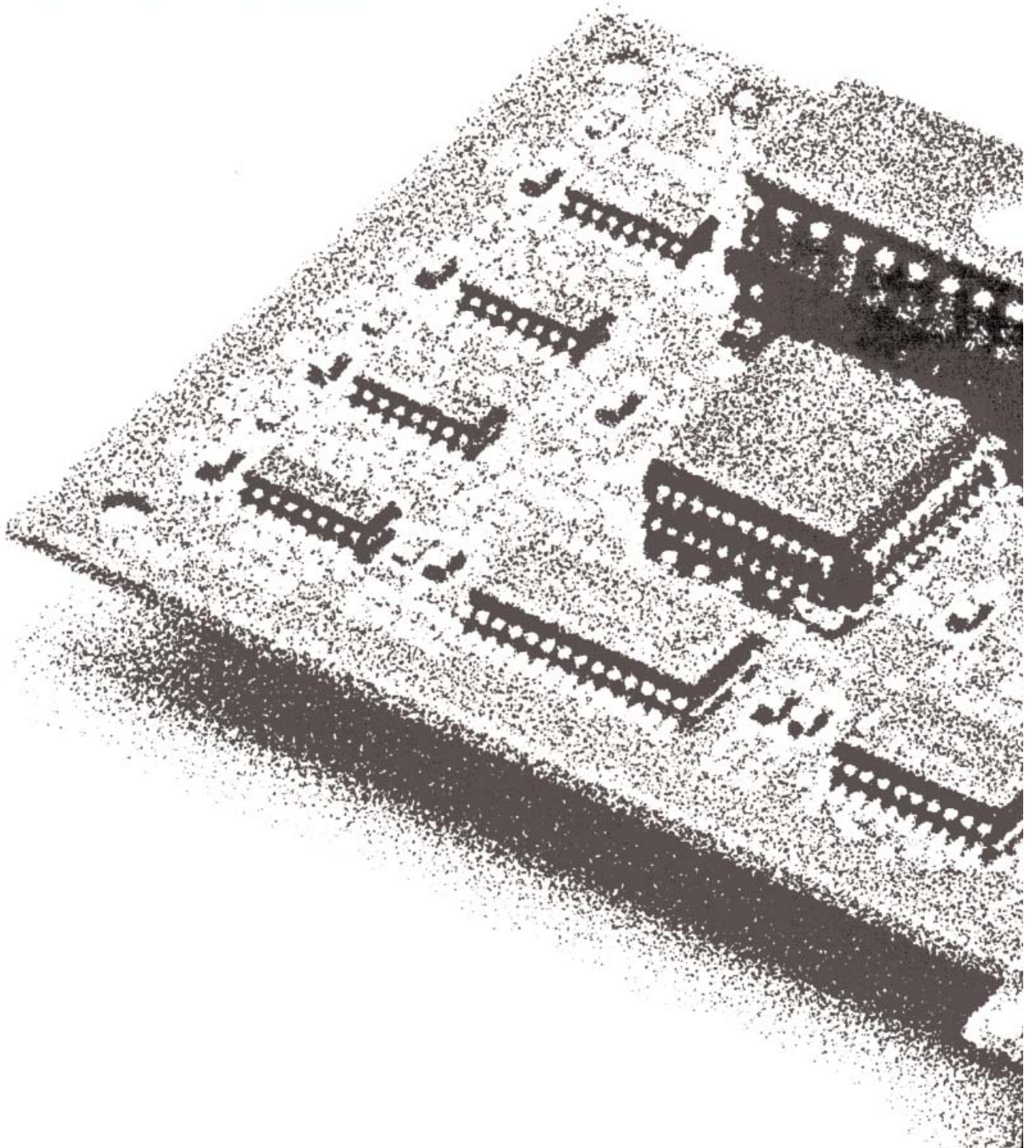

Apple II 3.5 Disk
Controller Card
Owner's Guide



Limited Warranty on Media and Replacement

If you discover physical defects in the manuals distributed with an Apple product or in the media on which a software product is distributed, Apple will replace the media or manuals at no charge to you, provided you return the item to be replaced with proof of purchase to Apple or an authorized Apple dealer during the 90-day period after you purchased the software. In addition, Apple will replace damaged software media and manuals for as long as the software product is included in Apple's Media Exchange Program. While not an upgrade or update method, this program offers additional protection for two years or more from the date of your original purchase. See your authorized Apple dealer for program coverage and details. In some countries the replacement period may be different; check with your authorized Apple dealer.

ALL IMPLIED WARRANTIES ON THE MEDIA AND MANUALS, INCLUDING IMPLIED WARRANTIES OF MERCHANTABILITY AND FITNESS FOR A PARTICULAR PURPOSE, ARE LIMITED IN DURATION TO NINETY (90) DAYS FROM THE DATE OF THE ORIGINAL RETAIL PURCHASE OF THIS PRODUCT.

Even though Apple has tested the software and reviewed the documentation, APPLE MAKES NO WARRANTY OR REPRESENTATION, EITHER EXPRESSED OR IMPLIED, WITH RESPECT TO SOFTWARE, ITS QUALITY, PERFORMANCE, MERCHANTABILITY, OR FITNESS FOR A PARTICULAR PURPOSE. AS A RESULT, THIS SOFTWARE IS SOLD "AS IS," AND YOU, THE PURCHASER, ARE ASSUMING THE ENTIRE RISK AS TO ITS QUALITY AND PERFORMANCE.

IN NO EVENT WILL APPLE BE LIABLE FOR DIRECT, INDIRECT, SPECIAL, INCIDENTAL, OR CONSEQUENTIAL DAMAGES RESULTING FROM ANY DEFECT IN THE SOFTWARE OR ITS DOCUMENTATION, even if advised of the possibility of such damages. In particular, Apple shall have no liability for any programs or data stored in or used with Apple products, including the costs of recovering such programs or data.

THE WARRANTY AND REMEDIES SET FORTH ABOVE ARE EXCLUSIVE AND IN LIEU OF ALL OTHERS, ORAL OR WRITTEN, EXPRESSED OR IMPLIED. No Apple dealer, agent, or employee is authorized to make any modification, extension, or addition to this warranty.

Some states do not allow the exclusion or limitation of implied warranties or liability for incidental or consequential damages, so the above limitation or exclusion may not apply to you. This warranty gives you specific legal rights, and you may also have other rights which vary from state to state.

Important

This equipment has been tested and found to comply with the limits for a Class B digital device in accordance with the specifications in Part 15 of FCC rules. See instructions if interference to radio or television reception is suspected.

DOC Class B Compliance This digital apparatus does not exceed the Class B limits for radio noise emissions from digital apparatus set out in the radio interference regulations of the Canadian Department of Communications.

Observation des normes—Classe B Le présent appareil numérique n'émet pas de bruits radioélectriques dépassant les limites applicables aux appareils numériques de la Classe B prescrites dans les règlements sur le brouillage radioélectrique édictés par le Ministère des Communications du Canada.



Apple II 3.5 Disk
Controller Card
Owner's Guide

 Apple Computer, Inc.

This manual is copyrighted by Apple or by Apple's suppliers, with all rights reserved. Under the copyright laws, this manual may not be copied, in whole or in part, without the written consent of Apple Computer, Inc. This exception does not allow copies to be made for others, whether or not sold, but all of the material purchased may be sold, given, or lent to another person. Under the law, copying includes translating into another language.

The Apple logo is a registered trademark of Apple Computer, Inc. Use of the "keyboard" Apple logo (Option-Shift-K) for commercial purposes without the prior written consent of Apple may constitute trademark infringement and unfair competition in violation of federal and state laws.

©Apple Computer, Inc., 1991
20525 Mariani Avenue
Cupertino, CA 95014-6299
(408) 996-1010

Apple, the Apple logo, AppleTalk, GS/OS, Macintosh, ProDOS, and IIGS are registered trademarks of Apple Computer, Inc.

SuperDrive and UniDisk are trademarks of Apple Computer, Inc.

ITC Garamond and ITC Zapf Dingbats are registered trademarks of International Typeface Corporation.

Simultaneously published in the United States and Canada.

Mention of third-party products is for informational purposes only and constitutes neither an endorsement nor a recommendation. Apple assumes no responsibility with regard to the performance or use of these products.



Contents

Radio and television interference / iii

Preface About this Guide / v

What's in this guide / vi

Conventions used in this guide / vi

1 Introduction / 1

Overview / 2

Your Apple II 3.5 Disk Controller Card package / 3

2 Installing the Card in your Apple IIGS / 5

Getting started / 6

Selecting a card slot / 6

Installing the card / 8

Taking the next steps / 13

3 Installing the Card in your Apple IIe / 15

Getting started / 16

Selecting a card slot / 16

Installing the card / 18
Taking the next steps / 23

4 Setting Up Your Floppy Disk Drive / 25

Connecting a single drive / 26
Connecting more than one disk drive / 27
 Special rules for SuperDrives / 28
 Special rules for UniDisk 3.5 drives / 30
Configuring your drive utility software under GS/OS / 30
 Activating the slot using the text Control Panel / 31
 Installing the floppy drive utility software / 33
Initializing a disk / 35
 Initializing a disk under GS/OS / 36
 Initializing a disk under ProDOS 8 / 38
If you need more help / 41

5 Troubleshooting / 43

Problems and solutions / 44
Service and support / 46

Appendix: Technical Specifications / 49

Glossary / 51

Index / 53

Radio and television interference

The equipment described in this manual generates, uses, and can radiate radio-frequency energy. If it is not installed and used properly—that is, in strict accordance with Apple's instructions—it may cause interference with radio and television reception.

This equipment has been tested and found to comply with the limits for a Class B digital device in accordance with the specifications in Part 15 of FCC rules. These specifications are designed to provide reasonable protection against such interference in a residential installation. However, there is no guarantee that interference will not occur in a particular installation.

You can determine whether your computer system is causing interference by turning it off. If the interference stops, it was probably caused by the computer or one of the peripheral devices.

If your computer system does cause interference to radio or television reception, try to correct the interference by using one or more of the following measures:

- Turn the television or radio antenna until the interference stops.
- Move the computer to one side or the other of the television or radio.
- Move the computer farther away from the television or radio.
- Plug the computer into an outlet that is on a different circuit from the television or radio. (That is, make certain the computer and the television or radio are on circuits controlled by different circuit breakers or fuses.)

If necessary, consult your authorized Apple dealer or an experienced radio/television technician for additional suggestions. You may find helpful the following booklet, prepared by the Federal Communications Commission: *Interference Handbook* (stock number 004-000-00345-4). This booklet is available from the U.S. Government Printing Office, Washington, DC 20402.

- △ **Important** Changes or modifications to this product not authorized by Apple Computer, Inc., could void the FCC Certification and negate your authority to operate the product. This product was tested for FCC compliance under conditions that included the use of shielded cables and connectors between system components. It is important that you use shielded cables and connectors to reduce the possibility of causing interference to radios, television sets, and other electronic devices. For Apple peripheral devices, you can obtain the proper shielded cables from your authorized Apple dealer. For non-Apple peripheral devices, contact the manufacturer or dealer for assistance. △



Preface About this Guide

This guide provides you with all the information you need to install an Apple® II 3.5 Disk Controller Card and disk drive utility software on your Apple II computer. The disk controller card allows you to use 3.5-inch floppy disk drives, including the Apple SuperDrive™ and Apple 3.5 Drive, with an Apple IIGS® or Apple IIe computer. This card also supports the operation of older model Apple II UniDisk™ 3.5 drives with Apple IIe computers.

This guide assumes that you have some basic familiarity with your Apple IIGS or Apple IIe computer. If you want to review information regarding the use of your computer, check the manual that came with your computer.

What's in this guide

This guide tells you how to install an Apple II 3.5 Disk Controller Card in your computer, connect a disk drive, and configure your software so that the drive operates properly.

- Chapter 1, “Introduction,” gives you an overview of the disk controller card and describes the contents of the product package.
- Chapter 2, “Installing the Card in your Apple IIgs,” tells you how to install the disk controller card in an Apple IIgs computer.
- Chapter 3, “Installing the Card in your Apple IIe,” tells you how to install the disk controller card in an Apple IIe computer.
- Chapter 4, “Setting Up Your Floppy Disk Drive,” provides information on how to connect your disk drive to the disk controller card, and if you have an Apple IIgs, how to install the drive utility software and activate the card's slot. It also tells you how to initialize a disk under the GS/OS* or ProDOS* 8 operating system.
- Chapter 5, “Troubleshooting,” provides guidelines for solving common drive-related problems, as well as information on finding service and support in your area.
- “Appendix: Technical Specifications” provides detailed technical specifications for the Apple II 3.5 Disk Controller Card.

Conventions used in this guide

The following paragraphs illustrate several typographical conventions that are used in this book to help make learning easier.

When a new term is used, the term appears in **boldface** type. Such terms are defined in more detail in the glossary. (The glossary also defines many related terms that don't appear in the text.)

- ▲ **Warning** Warnings like this one alert you to situations in which you might damage your equipment or lose data if you don't follow the instructions carefully. ▲

△ **Important** Material set off like this is essential; read it before continuing. △

◆ **By the way** Paragraphs like this one contain interesting sidelights or information for specific audiences. ◆



1 Introduction

The Apple II 3.5 Disk Controller Card improves the performance of your Apple IIgs or Apple IIe computer by allowing you to connect high-capacity Apple SuperDrives to your computer. With these floppy-disk drives, you'll be able to use disks with almost twice the storage capacity of older 800K disks. The disk controller card also offers you the flexibility of using older model 3.5-inch disk drives with your computer, in addition to SuperDrives.

This chapter provides information on these topics:

- an overview of what the Apple II 3.5 Disk Controller Card does and which drives you can use with it
- a list of what's inside your Apple II 3.5 Disk Controller Card package

Overview

The Apple II 3.5 Disk Controller Card is a **controller card** that allows you to use 3.5-inch **floppy disk drives** with an Apple IIGS or Apple IIe computer. You install this card in one of the **slots** inside your computer, then mount the card's connector to the computer's back panel so that you can connect drives to it. You can **daisy-chain** up to two disk drives to a card.

The disk controller card works with these floppy disk drives:

- Apple SuperDrive
- Apple 3.5 Drive
- Apple II UniDisk 3.5

Each type of drive is clearly identified on its underside, and a UniDisk 3.5 drive can be easily identified by its white, rather than platinum gray color. (This card doesn't support 5.25-inch drives—see the manual that comes with these drives for instructions on how to connect them to your computer.)

If you have an Apple IIe, you need an Apple II 3.5 Disk Controller Card to use any of these drives.

If you have an Apple IIGS, installing an Apple II 3.5 Disk Controller Card is the only way you can connect a SuperDrive *and* use 1.4 MB **high-density (HD) disks** with your computer. (You can connect a SuperDrive directly to the computer's built-in **Smart Port** without having to install a disk controller card, but the drive will only be able to read and write to 800K disks.) The advantage of using an Apple SuperDrive is that it allows you to use disks with almost twice the storage capacity of earlier model drives.

If you want to use UniDisk 3.5 drives with your computer, there are special configuration rules that you must follow. Specifically, this card doesn't support UniDisk 3.5 drives on an Apple IIGS running GS/OS. If you want to use these drives with an Apple IIGS running GS/OS, you must connect them to the built-in Smart Port on the computer's back panel. In addition, if you daisy-chain one of these drives with a different disk drive model, you must place the UniDisk drive at the end of the chain.

See Chapter 4, "Setting Up Your Floppy Disk Drive," on page 25 for more details.

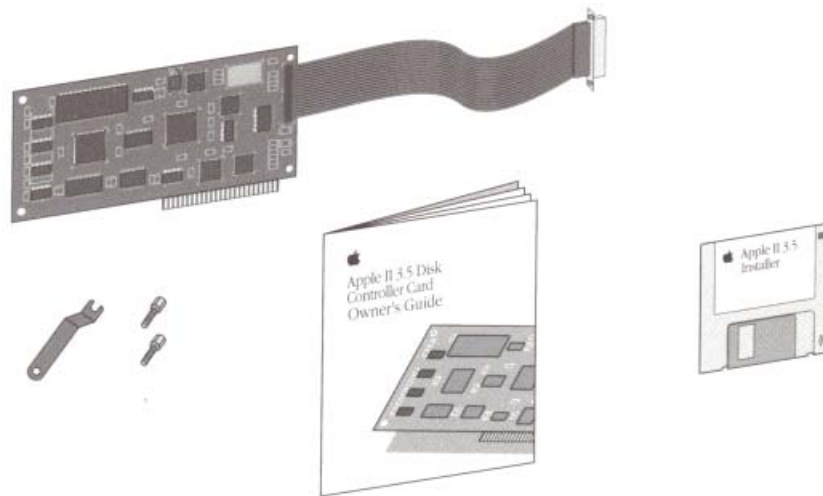

Figure 1-1 Contents of the Apple II 3.5 Disk Controller Card package

Your Apple II 3.5 Disk Controller Card package

Check to see that your Apple II 3.5 Disk Controller Card package contains the following items (see Figure 1-1):

- the disk controller circuit board with a ribbon cable and cable connector enclosed in an antistatic bag (be sure to keep the disk controller card inside the bag until you are instructed to remove it)
- a small wrench and two jack screws used to connect the card's cable connector to your computer
- this guide, the *Apple II 3.5 Disk Controller Card Owner's Guide*
- a 3.5-inch disk, *Apple II 3.5 Installer* disk (Note: an Apple IIe doesn't require drive installation software, but this disk includes a copy of the latest Apple IIe System Software.)
- warranty and registration cards

Now that you're sure your Apple II 3.5 Disk Controller Card package is complete, you can proceed to the installation instructions. The next chapter tells you how to install the controller card in your computer.



2 Installing the Card in your Apple IIgs

This chapter tells you how to install the Apple II 3.5 Disk Controller Card in an Apple IIgs computer. The procedures take only a few minutes—you just insert the card into a slot on the computer's main circuit board and screw the card's port connector to the back of your computer. The only tool you'll need is the small metal wrench supplied with the card.

Getting started

Installing your disk controller card in an Apple IIgs will only take a few minutes.

Before you begin the installation procedure, you should have the following components:

- an Apple IIgs computer
- an Apple IIgs System Disk 5.0.4 (**GS/OS**), an Apple II System Disk 3.2 (**ProDOS 8**), or later versions (check the version number on your original startup disk)
- the Apple II 3.5 Disk Controller Card, stored in its antistatic bag
- the small wrench and two jack screws included in your disk controller card package

Selecting a card slot

This section explains how to select the slot where you will install your Apple II 3.5 Disk Controller Card.

The recommended expansion slot for this card is slot 5. If this slot is already in use, slot 7 is the next best choice, as long as you don't need to insert a hard disk drive or network card in slot 7, or use built-in AppleTalk. There are other slots in which your card will work, depending on your system configuration. For more detailed information about choosing slots for your peripheral cards, see the manual that came with your computer.

Consider the following important issues before you select a slot:

- You won't be able to connect a device to the corresponding **built-in port** for any slot you use.
- Never put your card in slot 3—the computer's video **firmware** interferes with the card's functions.
- If you plan to use a UniDisk 3.5 with your Apple IIgs running GS/OS, you'll have to connect the UniDisk 3.5 drive to the computer's built-in Smart Port. Since slot 5 is electrically linked to the Smart Port, you can't use a card in slot 5 when a drive is connected to this port.

See the following table if you are unable to use one of the recommended slots and need to choose another. Figure 2-1 shows the built-in ports and port openings on the back of the Apple IIgs computer.

Slot Number	Recommended Usage	Apple II 3.5 Controller Card Capable	Deactivated Port
1	Printers or other serial devices	Yes	Printer port
2	Modems	Yes	Modem port
3	Video devices	No	None
4	Mouse devices	Yes*	Mouse port
5	3.5-inch floppy disk drives	Yes	Disk drive port (Smart Port)
6	5.25-inch floppy disk drives	Yes	Disk drive port
7	Hard disk drives or network devices	Yes†	None

* A mouse connected to the built-in mouse port will not work properly if you put a card into slot 4 in an Apple IIgs computer with a ROM version earlier than Version 3.

† Using built-in AppleTalk® deactivates this slot.

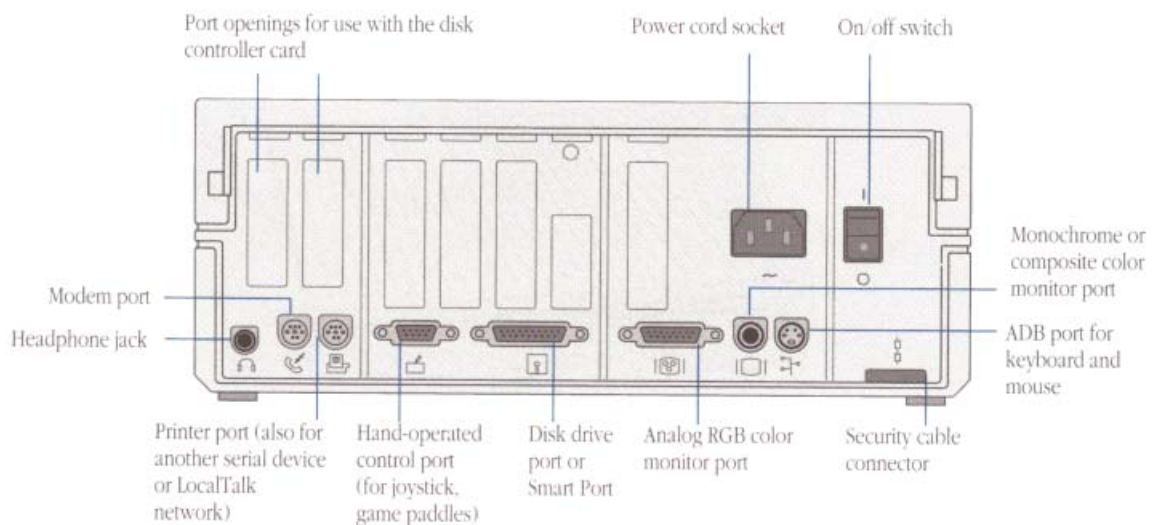

Figure 2-1 Locations of built-in ports and port openings on the Apple IIgs back panel

Installing the card

This section tells you how to install the Apple II 3.5 Disk Controller Card in an Apple IIgs computer. You'll learn how to open your computer's lid and insert the card into a slot on the main circuit board. Then you'll learn how to mount the metal connector on the installed card to computer's back panel.

Follow these steps to install the card:

1 Make sure the power to your computer is off.

- △ **Important** Turn the computer's power off, but leave the power cord plugged into a grounded outlet. Even with the power turned off, the power cord acts as a ground for the computer system, protecting it from static electricity. △

2 Remove the computer's lid.

Wrap your hands around the rear corners of the computer's case and push in the lid latches with your index fingers while you lift the lid with your thumbs and middle fingers. When you feel the lid release, slowly lift it all the way off the case and set it aside.

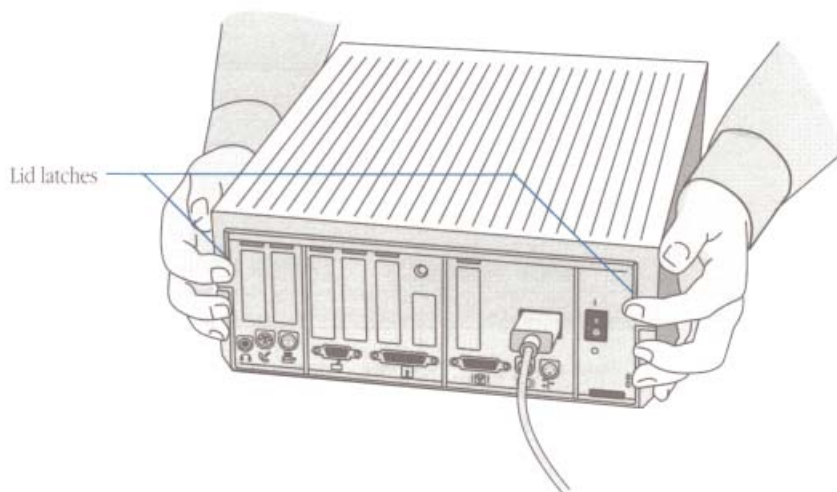

3 **After the power supply has cooled down, touch the metal part of it.**

Touching the power supply case discharges any static electricity that may have built up on your clothes or body.

- ▲ **Warning** Remember, the power supply can get very hot in normal use. If the computer has been on, be sure you wait at least five minutes for the case to cool down before you touch it. ▲

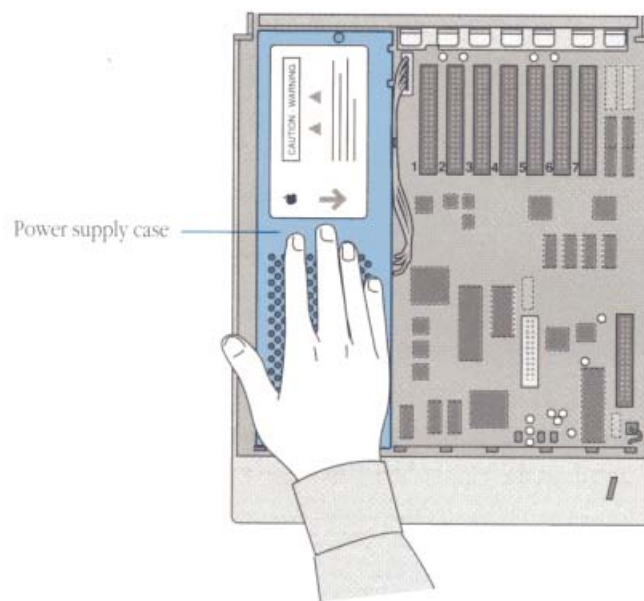

4 Remove the plastic cap from one of the port openings in the back panel of the computer.

Choose one of the port openings to mount the port connector to—either of the openings in front of slots 6 or 7 is the proper size. To remove the cap, turn the metal cap retainer (from inside the case) 90 degrees counterclockwise. Then remove the cap itself.

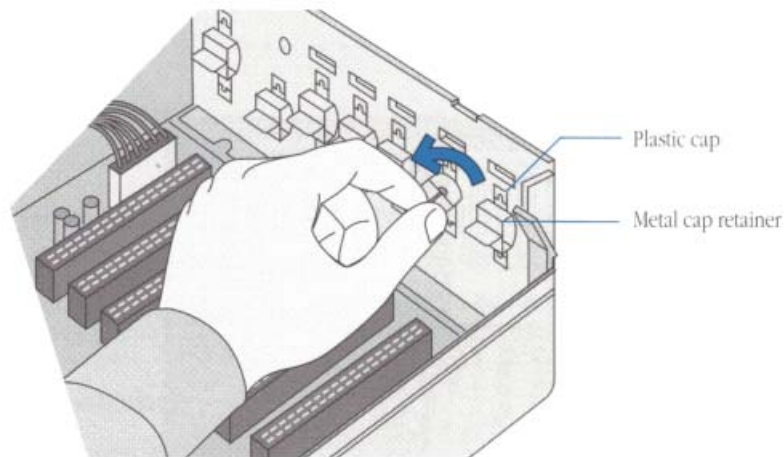

▲ **Warning** Make sure the metal cap retainer doesn't fall into the computer case. Leaving a loose piece of metal on the circuit board is likely to cause problems in the future. ▲

5 Unpack the card

Keep the card in its protective, antistatic bag until you're ready to install it. When you take the card out of its bag, hold it by the edges, not by the components.

△ **Important** Be sure not to touch the gold-plated contacts at the edge of the card. Oil or moisture from your hands can attract dust that may interfere with the connection, electrically insulating the card from the computer. △

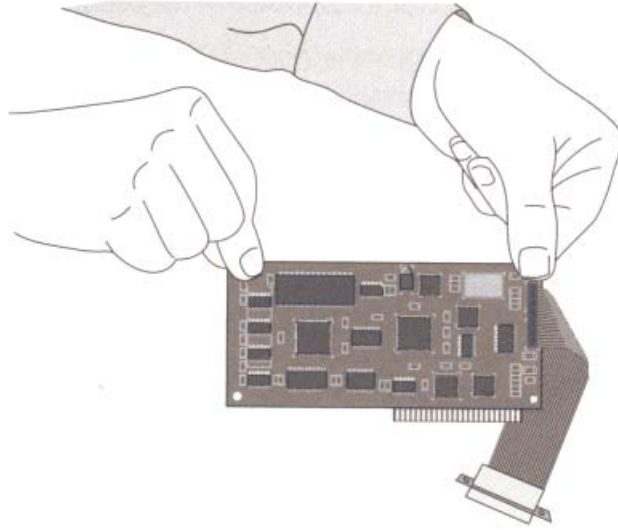

6 Insert the card in the slot.

Firmly press the card edge with the gold-plated contacts into the slot on the main circuit board that you chose in the previous section, making sure the component side of the card faces away from the power supply.

Rock the card gently forward and back until it's seated in the slot. Do not wiggle it from side to side.

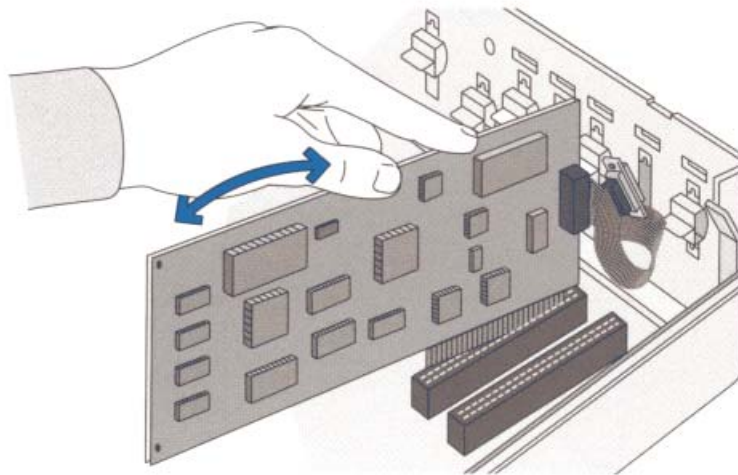

7 Attach the card's cable connector to the inside of the computer's back panel.

Hold the cable's port connector against the inside of the port opening. Reach behind the computer and feed the two jack screws through the holes above and below the opening and into the threaded holes on the connector. Use the small wrench to tighten the screws.

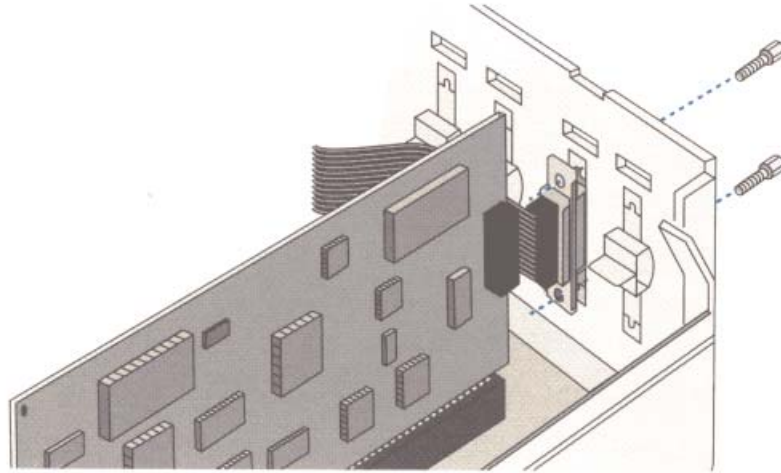

By anchoring the connector to the back panel, you reduce stress on the cable and form a seal between the electromagnetic shielding on the computer's case and the shielding on the connector. This seal substantially reduces the possibility that your computer will generate radio-frequency interference.

8 Replace the computer's lid.

Lay the front edge of the lid in the groove in the front of the computer's case and lower the back edge of the lid into place. Press down on the back corners of the lid until you hear the latches snap shut.

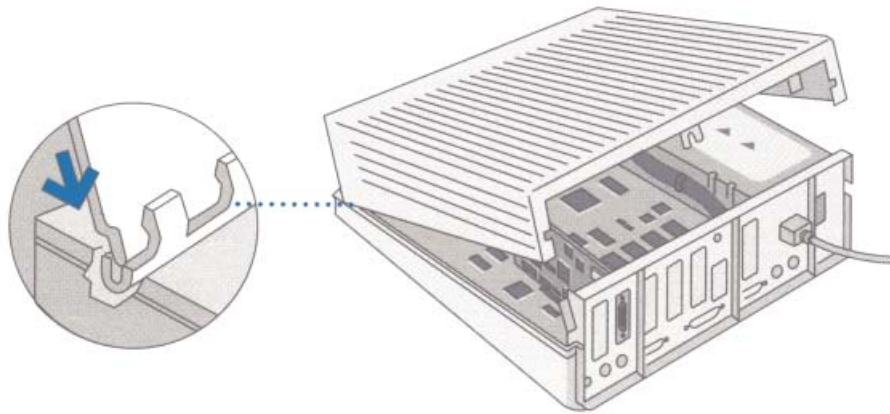

Taking the next steps

Next you'll connect your drive to the computer and configure your software so that the drive operates properly. Skip the next chapter and see Chapter 4, "Setting Up Your Floppy Disk Drive," on page 25.



3 Installing the Card in your Apple IIe

This chapter tells you how to install the Apple II 3.5 Disk Controller Card in an Apple IIe computer. The procedures take only a few minutes—you just insert the card into a slot on the computer's main circuit board and screw the card's port connector to the back of your computer. The only tool you'll need is the small metal wrench supplied with the card.

Getting started

Installing your card in an Apple IIe will only take a few minutes.

Before you begin the installation procedure, you should have the following components:

- an Apple IIe computer
- an Apple II System Disk 3.2 or later version (check the version number on your original startup disk, and if you need the latest software, copy it from the *Apple II 3.5 Installer* disk)
- the disk controller card, stored in its antistatic bag
- the small wrench and two jack screws included in the Apple II 3.5 Disk Controller Card package

Selecting a card slot

This section explains the important issues you must consider when you select the slot for your Apple II 3.5 Disk Controller Card. The recommended expansion slot for this card is slot 5. If this slot is already in use, slot 7 is the next best choice, as long as you don't need to install a hard disk drive or network card in this slot. Your disk controller card will work in other slots, depending on your system configuration. See the table on the next page if you are unable to use one of the recommended slots and need to choose another.

- △ **Important** Never put your card in slot 3—the computer's video firmware interferes with the disk controller card's operation. △

If you intend to use your new floppy drive as your startup device, put the disk controller card in a slot with a higher number than the slots where you have other potential startup devices (hard disk drives or RAM cards) connected. The computer looks first for a startup program on the device connected to the highest-numbered slot. If you do not intend to use a floppy disk drive as your startup drive, put it in a slot with a lower number than the slot your startup device is connected to.

Slot Number	Recommended Usage	Apple II 3.5 Disk Controller Card Capable
1	Printers or other serial devices	Yes
2	Modems	Yes
3	Video devices	No
4	Mouse devices	Yes
5	3.5-inch floppy disk drives	Yes
6	5.25-inch floppy disk drives	Yes
7	Hard disk drives or network devices	Yes

◆ **Note** For more detailed information about choosing slots for your peripheral cards, see the manual that came with your computer. ◆

Figure 3-1 shows the built-in ports and port openings on the back of the Apple IIe computer.

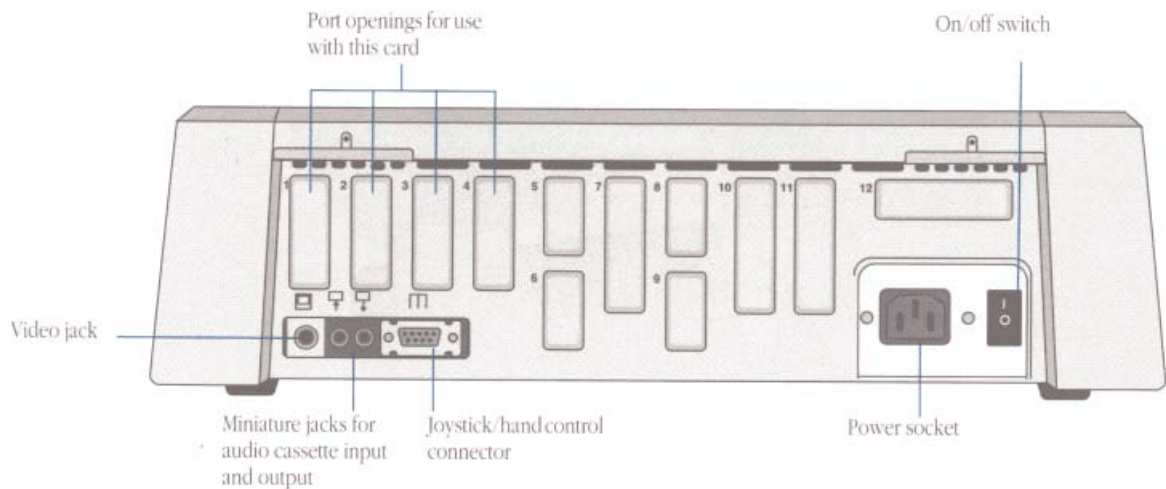

Figure 3-1 Locations of built-in ports and port openings on the Apple IIe back panel

Installing the card

This section tells you how to install the Apple II 3.5 Disk Controller Card in an Apple IIe computer. You'll learn to open your computer's lid and insert the card into a slot on the main circuit board. Then you'll learn to mount the metal connector on the installed card to the computer's back panel.

Follow these steps to install the card:

1 Make sure the power to the computer is off.

- △ **Important** Turn the computer's power off, but leave the power cord plugged into a grounded outlet. Even with the power turned off, the power cord acts as a ground for the computer system, protecting it from static electricity. △

2 Remove the computer's lid.

With both hands, grasp the tabs that project from the back of the computer cover. Pull up firmly until the corner fasteners release. Slide the cover back, away from the keyboard, until you can lift it up and off.



3 **After the power supply has cooled down, touch the metal part of it.**

Touching the power supply case discharges any static electricity that may have built up on your clothes or body.

- ▲ **Warning** Remember, the power supply can get very hot in normal use. If the computer has been on, be sure you wait at least five minutes for the case to cool down before you touch it. ▲

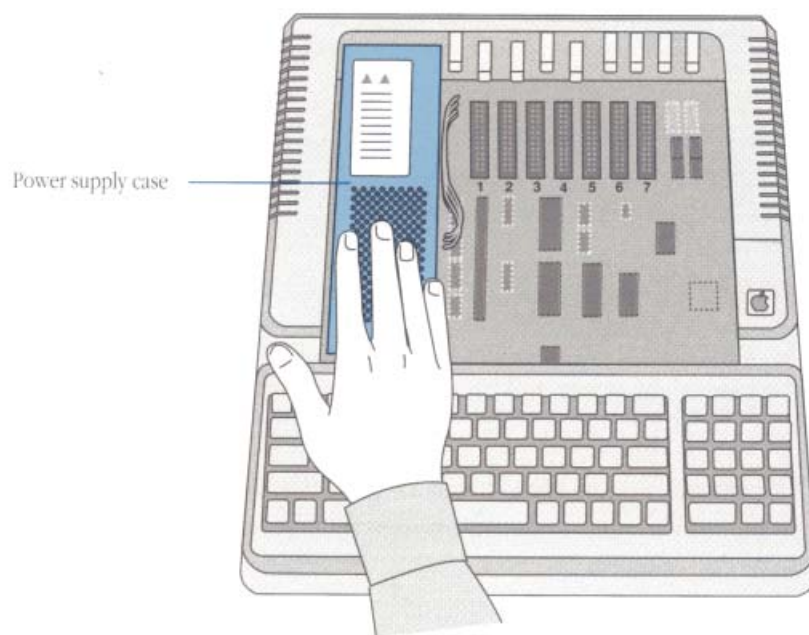

4 Remove the plastic cap from one of the port openings in the back panel of the computer.

Choose port opening 1, 2, 3, or 4. Open the cap by pulling up and pushing out on the tab that protrudes from the cap.

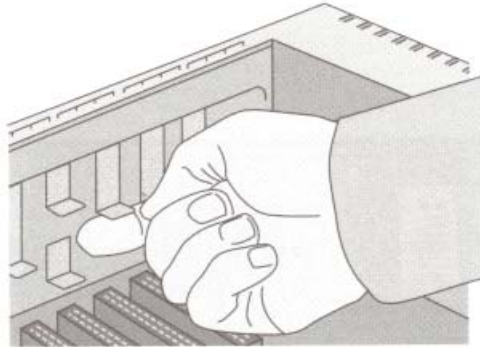

5 Unpack the card.

Keep the card in its protective, antistatic bag until you're ready to install it. When you take the card out of its bag, hold it by the edges, not by the components.

△ **Important** Be sure not to touch the gold-plated contacts at the edge of the card. Oil or moisture from your hands may interfere with the connection, electrically insulating the card from the computer. △

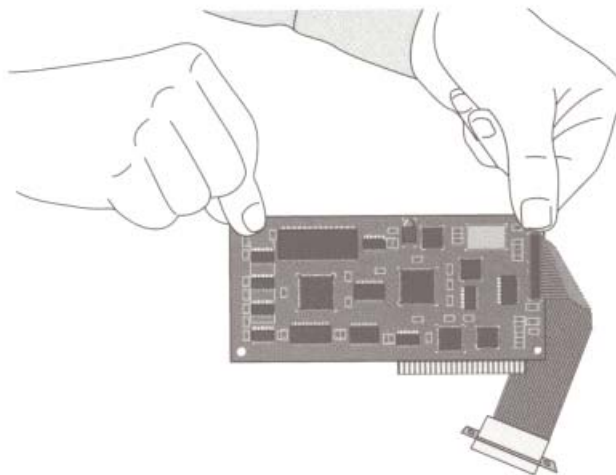

6 **Insert the card in the slot.**

Firmly press the card edge with the gold-plated contacts into the proper slot on the main circuit board, making sure the component side of the card faces away from the power supply.

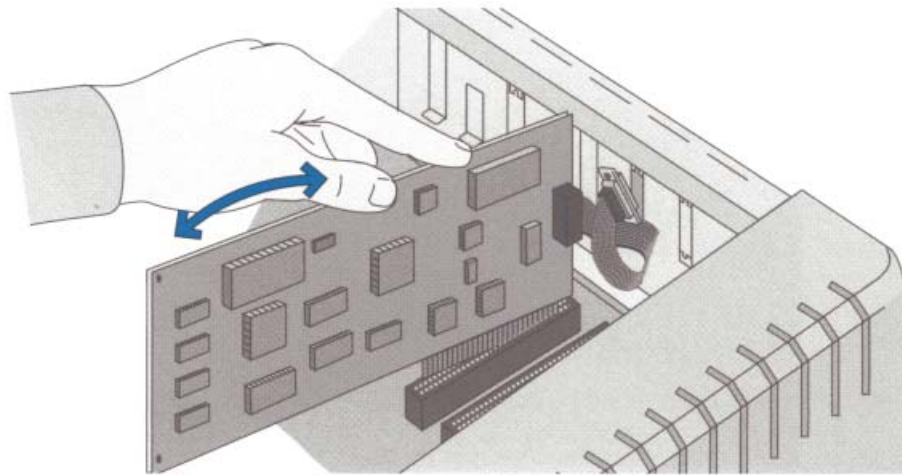

Rock the card gently forward and back until it's seated in the slot. Do not wiggle it from side to side.

7 Attach the card's cable connector to the inside of the computer's back panel.

Hold the cable's port connector against the inside of the opening. Reach behind the computer and feed the two jack screws through the holes above and below the opening and into the threaded holes on the connector. Use the small wrench to tighten the screws.

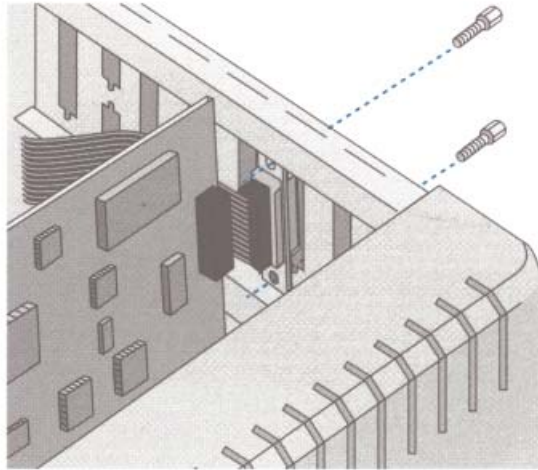

By anchoring the connector to the back panel, you reduce stress on the cable and form a seal between the electromagnetic shielding on the computer's case and the shielding on the connector. This seal substantially reduces the possibility that your computer will generate radio-frequency interference.

8 Replace the computer's lid.

Slip the front edge of the lid on, then lower the back edge into place. Press down on the back corners of the lid until you hear the latches click shut.

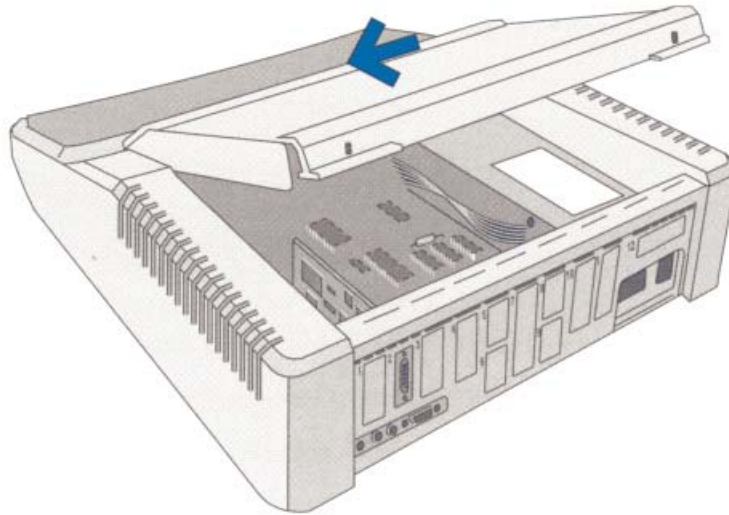

Taking the next steps

In the next chapter you'll learn how to connect your drive to the computer and initialize new disks.

111



4 Setting Up Your Floppy Disk Drive

This chapter tells you how to set up a 3.5-inch floppy drive to work with your Apple IIGs or Apple IIe computer, once your Apple II 3.5 Disk Controller Card is installed. The setup for an Apple IIe is very simple—you just connect the drive and **initialize** your disks as needed. With the higher-performance Apple IIGs, you'll also have to activate a disk drive slot, and if you're running GS/OS, you'll have to install disk **drive utility software**. At the end of this chapter there's a section on how to initialize disks.

This chapter contains information on these topics:

- connecting one or more drives to your computer
- configuring your drive utility software under GS/OS
- initializing disks under GS/OS or ProDOS 8 operating systems

Connecting a single drive

Connecting a disk drive to your Apple IIgs or Apple IIe computer takes only a few seconds and requires no special tools. Follow these steps to connect your disk drive:

1 Make sure the computer is plugged in and switched off.

▲ **Warning** Connecting a disk drive when the power is on could seriously damage the disk drive, the controller card, and your computer. ▲

2 Connect the disk drive cable to the disk controller card's connector on the back panel.

Plug the drive cable connector into the disk controller card connector on the back panel. Gently tighten the thumbscrews on each side to secure the connection.

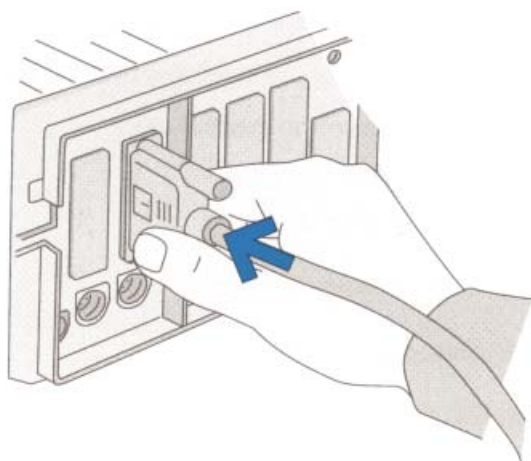

After connecting your disk drive, Apple IIgs users should read the “Activating the slot using the text Control Panel” section on page 31.

◆ **Note** If you’re using an Apple IIe, you won’t need to activate a slot and install drive utility software because these functions are built into your system software. You can proceed directly to “Initializing a disk under ProDOS 8” on page 38. ◆

Connecting more than one disk drive

Connecting a second disk drive to your Apple IIgs or Apple IIe computer takes only a few seconds and requires no special tools. You'll need to daisy-chain the second drive to the first drive rather than connecting it directly to the computer. If you're using more than one type of drive in this daisy-chain, make sure you read the special rules starting on page 28 concerning the usage of SuperDrives and UniDisk 3.5 drives.

To complete this procedure follow these steps:

1 Make sure the computer is plugged in and switched off.

▲ **Warning** Connecting a disk drive when the power is on could seriously damage the disk drive and your computer. ▲

2 Connect the second disk drive's cable to the connector on the back of the first drive.



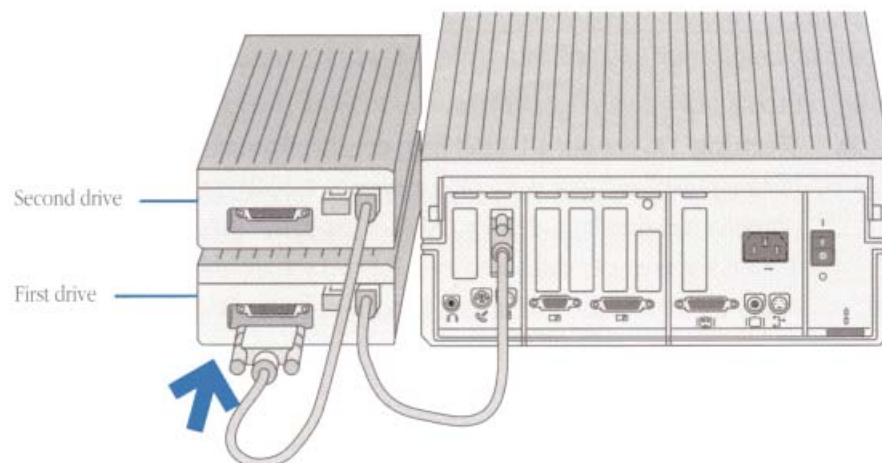



Leave the first disk drive plugged into the computer, and plug the second disk drive's cable into the connector on the back of the first drive. If your first disk drive is a SuperDrive, you'll have to remove the plastic cap off the back-side connector with a screw driver before you can attach the second disk drive. Once you've plugged the cable in, gently tighten the thumbscrews on each side to secure the connection.



Special rules for SuperDrives

The SuperDrive uses 1.4 MB high-density disks to give you more data storage capacity. In addition, it can read and write data and applications on 800K disks. The disk drive recognizes the difference between 1.4 MB high-density disks and 800K double-density disks, and properly initializes either of these disk types.

UniDisk 3.5 and Apple 3.5 disk drives, on the other hand, can't use 1.4 MB high-density disks. The following table shows you which combinations of disks and drives you can use together.

Disk Drive Model	Compatible Disks	
SuperDrive		
Apple 3.5 Drive		
Unidisk 3.5		

- ▲ **Warning** Do not put a 1.4 MB high-density disk into an 800K drive. These disk drives cannot reliably read or write information to 1.4 MB high-density disks, and they cannot properly initialize high-density disks for use in the SuperDrive. (One quick way to identify 1.4 MB high-density disks is to look for two square holes in the upper edge of the disk, rather than the single hole found in 800K disks. See Figure 4-1 on page 29.) ▲

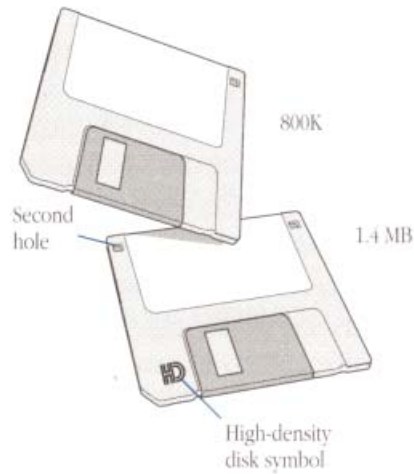

Figure 4-1 High-density and 800K disks

- ▲ **Warning** The program FastCopy that comes with the Apple II System Disk 3.2 does not properly copy 1.4 MB high-density disks. Use the system utilities in the Apple II 3.5 Installer disk to copy data to these disks. ▲

Keep the following important points in mind whenever you work with a combination of SuperDrives and 800K drives:

- If you accidentally put a 1.4 MB high-density disk into an 800K drive when you're running GS/OS, you'll be asked if you want to initialize the disk. Be sure that you eject the disk. Initializing the disk will destroy any data you have stored on that disk.
- Indicate clearly on the label of each 1.4 MB high-density disk that the disk should be used in SuperDrives only.
- Be sure to warn anyone who might use your disks or equipment that the high-density disks should only be used in SuperDrives.

Special rules for UniDisk 3.5 drives

If you want to use UniDisk 3.5 drives with your computer, there are special configuration rules that you need to follow. Specifically, this card doesn't support UniDisk 3.5 drives on an Apple IIgs running GS/OS. If you want to use these drives with an Apple IIgs, you need to connect them to the built-in Smart Port on the computer's back panel, making sure the disk drive controller card is not installed in slot 5. Also, when you add a UniDisk 3.5 drive to a disk drive card in an Apple IIe that already has a different model floppy disk drive attached, there is a restriction on the placement of the disk drive. Always place the UniDisk 3.5 drive at the end of the daisy-chain—in other words, make sure the UniDisk 3.5 drive is plugged into the first disk drive, not the card cable connector.

After connecting your drive, Apple IIgs users should read the section about activating your drive slot in the following section.

◆ **Note** If you're using an Apple IIe, you won't need to activate a slot and install drive utility software because these functions are built into your system software. You can proceed directly to "Initializing a disk under ProDOS 8," on page 38 at the end of this chapter. ◆

Configuring your drive utility software under GS/OS

There are two procedures to complete before you're ready to use your Apple II 3.5 Disk Controller Card on an Apple IIgs computer running GS/OS (Apple IIgs System Disk 5.0.4 or a later version.) You will:

- activate the slot where you inserted your drive controller card using the text Control Panel
- install new floppy drive utility software on your start-up disk

The following sections describe the steps involved in each of these procedures.

Activating the slot using the text Control Panel

Before your computer can communicate with a floppy disk drive, you must activate the slot into which you inserted your drive card. You'll be using the text Control Panel to complete this task.

With your computer turned off, insert your startup disk into the disk drive, then follow these steps:

- 1 **Switch on the computer's power.**
- 2 **Hold down the Command and Control keys while you press and then release the Escape (Esc) key.**

In a moment the Desk Accessories menu appears.



- 3 **Press the Down Arrow or the Up Arrow key until the Control Panel option is highlighted, then press Return.**



When you hold either key down, the highlighting cycles through the choices. Pressing Return when the Control Panel option is highlighted calls up the Control Panel main menu.

4 Press Down Arrow or Up Arrow until the Slots option is highlighted, then press Return.

When you hold either key down, the highlighting cycles through the choices. Pressing Return when the Slots option is highlighted displays the Slots menu.

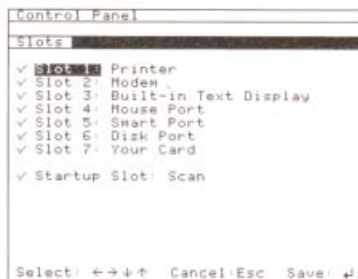

5 Press Down Arrow or Up Arrow until the slot number you want to activate is highlighted, press Left or Right Arrow until you see the words Your Card, then press Return.

When a slot is activated, the words Your Card replace the words describing the slot's default usage.

△ **Important** Make sure you save this slot configuration change by pressing Return. △

6 Close the Control Panel by highlighting Quit, then pressing Return.

7 Close the Desk Accessories menu by highlighting Quit, then pressing Return.

8 Restart your computer.

Hold down the Command and Control keys, and then press and release the Reset key to restart your computer.

- △ **Important** Changes to the Slots options won't take effect until you restart the computer. △

You're now ready to proceed to the next section to install the drive utility software.

Installing the floppy drive utility software

The *Apple II 3.5 Installer* disk includes utility software that optimizes the performance of the drive connected to your Apple IIGS running GS/OS. On this disk, you'll find an Installer program that you can use to copy the new disk drive software to your current startup disk.

- △ **Important** Though it's possible to not use the Installer program and just copy over the drive utility files to your startup disk, it's better to use the Installer in order to make sure the right files are put in the proper folder on your startup disk. △

Follow these steps to install the disk drive software:

1 Start up the computer with your startup disk.

In a few moments you'll see a message that says "UniDisk 3.5 requires a driver. Install UniDisk 3.5 driver on boot disk and reboot system." Press Return and proceed to next step.

2 Insert the *Installer* disk into an empty drive.

In a few moments you'll see the Installer icon in the Apple IIGS.Files window.



- ◆ **Note for one-drive systems** If you have only one 3.5-inch disk drive, eject your system disk and insert the *Installer* disk. You'll have to swap disks during this procedure; just follow the instructions on the screen when you're prompted to insert a disk. ◆

3 Double-click the Installer icon to open it.

In a few moments you'll see the Apple II GS Installer window. The Update Selection window on the left of the screen displays an Apple Disk 3.5 option for the drive utility software. The window on the right corresponds to your current startup disk.

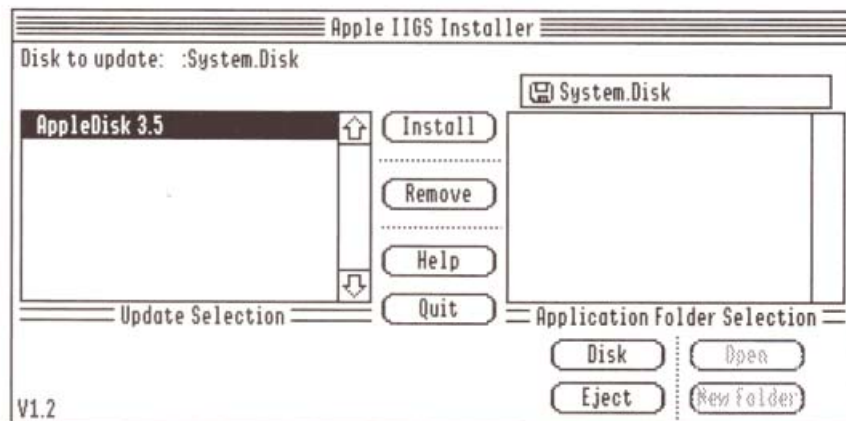

4 Verify that the name of your startup disk appears to the right of the words, “Disk to Update”.

If you want to update a different startup disk, click the Disk button in the lower right corner of the screen until the name of the disk you want to update appears to the right of the “Disk to Update” in the upper left corner. You can also press the Tab key to choose another disk to update.

5 Verify that the AppleDisk 3.5 update is highlighted, then click Install.

You can also select this update by using the Up or Down Arrow to highlight the line.

A series of messages and a “thermometer” indicator keep you informed about the progress of the installation. When the installation procedure is complete, you’ll see a dialog box letting you know whether the installation process was successful. (If it fails, the dialog box will indicate the reason.)

6 Click OK, then click Quit (or choose Quit from the File menu) to quit the Installer.

You will see a dialog box with a button labeled Restart System.

7 Click Restart System to restart your computer.

You're now ready to start using your floppy disk drive. If you're not familiar with working with disks, or you're using a SuperDrive for the first time, read the next section on initializing disks.

Initializing a disk

Before you can save information on a disk, the disk must be initialized. Initializing a disk does two things:

- It establishes a physical format on the disk. That is, it divides the disk into sections—somewhat like parking spaces in a parking lot—where information can be stored.
- It writes a file system to the disk. This is a system for organizing the sections so that the computer can keep track of where data is stored.

There are two occasions when you'll want to initialize a disk:

- when the disk has never been used before
- when you want to change a disk format from one file system to another

Apple II users running System Disk 5.0.4 (GS/OS) or System Disk 3.2 (ProDOS 8) should initialize disks in the **ProDOS disk format**. This section covers two different procedures for initializing disks, one for initializing disks on an Apple IIgs running GS/OS and one for initializing under ProDOS 8. In both procedures you'll select a file system. If you're using an Apple IIgs, you'll select an **interleave ratio**. This setting allows your computer to read and write information to your disk drive at the fastest possible speed.

Initializing a disk under GS/OS

If you're using an Apple IIgs running GS/OS, follow the steps listed below to initialize a disk for the first time.

If you're running ProDOS 8 on an Apple IIe or an Apple IIgs computer, see the next section, "Initializing a disk under ProDOS 8," on page 38.

1 Insert the disk you want to initialize into your disk drive.

In a few moments you'll see the initialization dialog box. There are minor variations in this dialog box depending on what GS/OS version you're running, but the steps that you go through are the same.

If the disk that you want initialize has already been formatted, you'll have to click on the disk icon, pull down the Disk menu from the desktop, select Initialize from this menu, then continue with the following steps. If the disk has not been formatted, the highlighted name will be "Untitled."

2 Type a name for the disk.

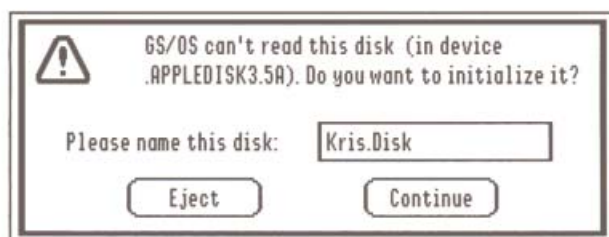

When naming disks in the ProDOS disk format, keep the following rules in mind:

- Start the name with a letter.
- Use no more than 15 characters.
- Don't use spaces.
- Don't use characters other than letters, numbers, or periods.
- No two disk icons on the desktop can have the same name

3 Click Continue.

Or, if you change your mind about initializing the disk, click Eject.

When you click continue, you'll see a dialog box similar to this one.

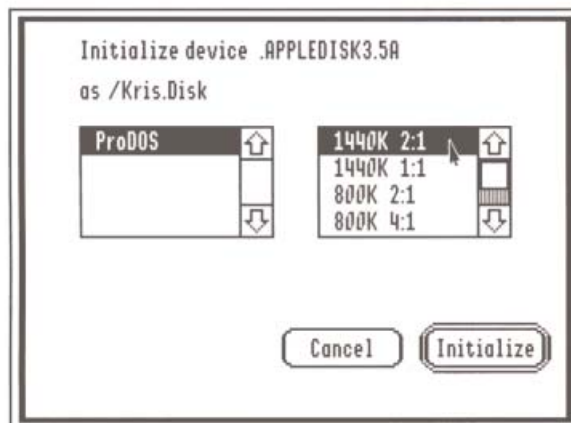

4 If necessary, select a file system and an interleave format.

When initializing a 3.5-inch disk, you rarely need to change the default settings for a file system and interleave format. In most cases you'll just have to make sure that the line item for the ProDOS file system is highlighted. Make sure that the default interleave option of 2:1 is highlighted, then move on to the next step.

◆ **Note** Interleave ratio settings optimize the performance of your drive and disks. Using disks with a non-recommended interleave won't prevent you from reading a disk, though it may slow down data access times. The 720K format option is designed for MS-DOS. Software is not yet available to read this media, but the option has been provided for potential development. ◆

5 Click Initialize or press Command-Return.

The disk will be initialized in the chosen format. When the initialization is complete, the disk icon appears on the desktop with the name you provided in step 2.

Initializing a disk under ProDOS 8

Follow these steps to initialize a disk for the first time if you're using an Apple IIgs or Apple IIe computer running ProDOS, using the System Utilities on your system disk. You'll need to know the slot number where your disk controller card is installed and the number of the drive you're using. (Drive 1 is the disk drive connected directly to the computer, and if you have a second disk drive, Drive 2 is the one daisy-chained to Drive 1.)

1 Insert a system disk in your disk drive.

You'll see the 3.5 Installer disk Main Menu after the computer starts up.



2 Press Down Arrow or Up Arrow until System Utilities is highlighted, then press Return.

When you hold either key down, the highlighting cycles through the choices. Press Return when the System Utilities module is highlighted.

- 3 Press Down Arrow or Up Arrow until Format a Disk is highlighted, then press Return.

```
Apple II System Utilities                               Main Menu
Version 3.1                                           ESC Quit

Work on Entire Disks                                Work on Individual Files
Catalog a Disk                                       Copy Files
List Volumes                                        Delete Files
Duplicate a Disk                                    Rename Files
Format a Disk                                       Lock/Unlock Files
Verify a Disk

Work on ProDOS Disks Only                            Other Options
Create Subdirectory                                  About the System Utilities
Set Prefix                                          Quit
Rename Volumes

Press ↓ ↑ → ← to select an option
Then press RETURN.
For Help: Press q!
```

- 4 Press Return again.
- 5 Enter your Apple II 3.5 Disk Controller Card slot number and drive number, then press Return.

Drive 1 is the disk drive connected directly to the computer, and if you have a second disk drive, Drive 2 is the one daisy-chained to Drive 1.

```
Apple II System Utilities                               Format a Disk
Version 3.1                                           ESC Main Menu

Where is your disk?
Slot: 0 Drive: 1

Press → ← to select an option
Press a number or ↓ ↑ to change values
Then press RETURN.
For Help: Press q!
```

6 Select the ProDOS Operating System option, then press Return.

Use the Up and Down Arrow keys to move from one option to the next until the ProDOS Operating System option is selected.

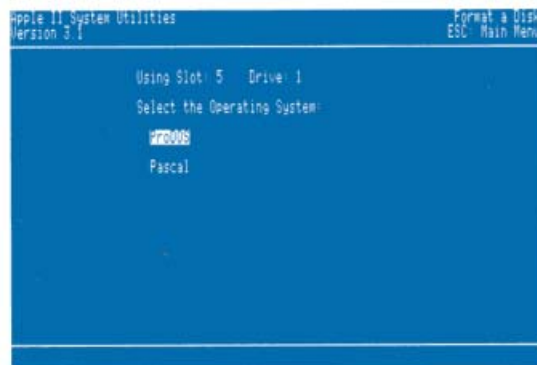

7 Type a name for the disk (referred to here as a volume), then press Return.

When naming disks in the ProDOS disk format, keep the following rules in mind:

- Start the name with a letter.
- Use no more than 15 characters.
- Don't use spaces.
- Don't use characters other than uppercase letters, numbers, or periods.

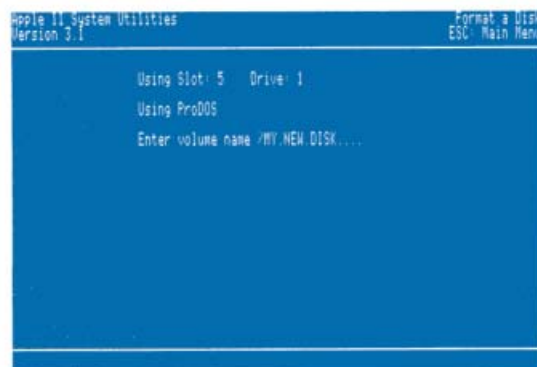

After entering the disk name and pressing Return, you will be prompted to place your disk in the disk drive. Press Return and the formatting will begin; a message appears on the screen when formatting is complete. These steps assume you're formatting new disks. If

you're formatting previously used disks, there will be an extra step warning you that you'll be erasing data on this disk.

If you need more help

At this point your floppy disk drive should be operational and you should know how to format disks. If this chapter hasn't provided an explanation for an unexpected situation or event, there are a number of places you can turn to for more information.

Start by checking the next chapter, "Troubleshooting," to see if there is a solution to any difficulties that you might be having.

To get more information on connecting your disk drive or working with disks, check the manual that comes with your floppy disk drive. For more information on choosing slots or installing utilities, see the manuals that came with your computer and system software.

1
2
3
4
5
6
7
8
9
10
11
12
13
14
15
16
17
18
19
20
21
22
23
24
25
26
27
28
29
30
31
32
33
34
35
36
37
38
39
40
41
42
43
44
45
46
47
48
49
50
51
52
53
54
55
56
57
58
59
60
61
62
63
64
65
66
67
68
69
70
71
72
73
74
75
76
77
78
79
80
81
82
83
84
85
86
87
88
89
90
91
92
93
94
95
96
97
98
99
100



5 Troubleshooting

This chapter contains a listing of situations that you may encounter and messages you might see when you use your Apple II 3.5 Disk Controller Card. Solutions are provided whenever possible. Also listed are sources for service if you are unable to resolve the problem.

Problems and solutions

Most problems you encounter will be associated with slot assignments and startup devices. The following are some situations that may occur and what can be done to correct them.

The slot activation that you made in your Apple IIgs Control Panel doesn't seem to have taken effect.

The changes that you made in the Slots menu may not have been saved. To correct this, repeat the steps outlined in the section on activating your card slot, making sure to press Return rather than Esc after setting the slot to Your Card. Then restart your computer.

If this still doesn't work, the problem could be that the battery on the computer's main circuit board is dead. To verify this, check to see if your computer is maintaining accurate time. Refer to the manual that came with your computer for instructions. Take your computer to the nearest authorized Apple service provider to get this battery replaced.

You can't erase or initialize a 3.5-inch disk because the appropriate buttons are dimmed in the Apple IIgs computer's Disk pull-down menu.

The selected disk is write-protected. To remove this write-protection follow these steps:

- Eject the disk by pressing the eject button on the disk drive.
- Slide the write-protect tab in the corner of the disk closed so you can't see through the small window.

Your computer doesn't recognize all the disk drives connected to the disk drive slot or port.

One of the following may be the cause:

- If you have more than one type of disk drive, you've connected the disk drives in the wrong order. UniDisk 3.5 drives must be placed at the end of a chain of disk drives. Shut down and switch off the computer, wait at least 15 seconds, and reconnect the disk drives in the correct order.
- You've connected more disk drives to the disk drive card than the computer can recognize. The Apple II 3.5 Disk Controller Card can accommodate a maximum of two

disk drives. Shut down and switch off the computer, wait at least 15 seconds, and remove the necessary drives to conform with the two-drive limit.

You don't hear your startup disk drive when you switch on the computer.

One of the following may be the cause:

- The disk drive is not connected to the computer. Switch off the computer, wait at least 15 seconds, and check to make sure the disk drive is properly connected.
- Your Apple IIGS computer's Control Panel setting for the startup slot may be incorrect. See "Activating the slot using the text Control Panel" in Chapter 4 on page 31 for more information. Then use the Slots control panel via the text Control Panel to change the startup slot as necessary.
- You've connected a UniDisk 3.5 to an Apple IIGS through the card connector rather than the computer's built-in Smart Port. Switch off the computer, wait at least 15 seconds, and connect the UniDisk drive directly to the Smart Port.

The disk drive doesn't work.

If the disk drive doesn't work, turn off your computer's power, open the computer's lid, and watch the LED (the small light on the controller card) located on the top edge of the disk controller card as you turn on the computer's power. If the LED blinks continuously or remains on after the computer is running, **turn off the computer** and try reseating the card in the slot. There could be corrosion on the gold card edge connector preventing the card from making good electrical contact.

- ▲ **Warning** To avoid electrical damage to you or your computer, be careful not to touch anything inside the computer while the lid is off and the power is on. Make sure to turn off the computer before reseating the card. ▲

If this doesn't solve the problem, then there could be a hardware problem with your disk controller card. Return the card to the authorized Apple dealer from whom it was purchased for either a warranty exchange or service.

The computer tries to start up using the “wrong” disk.

An Apple IIGS computer will attempt to start up from a disk in the disk drive connected to the highest-numbered slot or corresponding built-in port unless the Control Panel has been used to manually change the startup slot. To fix this problem, put your startup disk in the disk drive that the computer is using as the startup drive. Or change the Startup setting in the Control Panel to correspond to the device you want to use as a startup drive.

An Apple IIe computer will attempt to start up from a disk in the first disk drive connected to the highest-numbered slot. To fix this problem, put your startup disk in the disk drive that the computer is using as the startup drive, or turn off the computer and move the Apple II 3.5 Disk Controller Card to a higher slot number than the device that’s currently starting up.

Your computer doesn’t acknowledge that your drive is connected.

One of the following might be the cause:

- Your drive is connected to the disk controller card, but the corresponding slot setting in the control panel is not set to Your Card. To change the slot setting, see “Activating the slot using the text Control Panel,” on page 31.
- You’ve connected a UniDisk 3.5 drive and it is not at the end of the daisy chain of drives. Switch off the computer, wait at least 15 seconds, and then reconnect the disk drives so that the UniDisk 3.5 drive is last in the chain.
- You’ve connected a UniDisk 3.5 to an Apple IIGS through the card connector rather than the computer’s built-in Smart Port. Switch off the computer, wait at least 15 seconds, and connect the UniDisk drive directly to the Smart Port.
- Note that 5.25-inch drives are not supported by this card. Refer to the manual that came with the drive for instructions on how to connect these drives.

Service and support

To help you get the best performance from your system, Apple Computer, Inc., has established a worldwide network of full-support authorized Apple dealers. If you need answers to technical questions or information about product updates, your authorized

Apple dealer can help you. Your dealer has the latest information on new hardware and software products as well as product updates. If you wish to upgrade your system, your dealer can help you select compatible components.

If your Apple II 3.5 Disk Controller Card requires service, your local authorized Apple dealer is trained and ready to support you. Apple provides factory-quality parts and the latest diagnostic equipment to the authorized Apple service centers throughout the United States and Canada. Apple guarantees parts and warranty labor. (Regulations in each country determine the length of warranty. Some restrictions may apply, depending on the country of original purchase.)

If for some reason you cannot return to the authorized dealer from whom you purchased your system, go to the nearest authorized Apple service location. For the location nearest you in the United States or Canada, call or write to one of the following:

Apple Computer, Inc.
Attn: Customer Relations
20525 Mariani Avenue
Cupertino, CA 95014
USA
800-538-9696

Apple Canada, Inc.
7495 Birchmount Road
Markham, Ontario, L3R 5G2
Canada
800-268-7796 or 800-268-7637





Appendix: Technical Specifications

Microprocessor

65C02

Disk controller

SWIM

Memory

32K Static RAM

32K ROM

Connector

DB-19

Power dissipation

Less than 4 Watts

Environmental requirements

Operating temperature: 50° F to 104° F (10° C to 40° C)

Storage temperature: 50° F to 140° F (10° C to 60° C)

Relative humidity: 20% to 80% noncondensing



Glossary

application A computer program designed to solve a user problem, such as word processing, database management, graphics, or telecommunication.

built-in port A factory-installed socket on the back panel of the Apple IIgs for connecting peripheral devices.

controller card A removable printed-circuit board that plugs into one of a computer's slots, allowing the computer to use a peripheral device or to perform some subsidiary or peripheral function.

connector A physical device such as a plug used to connect one hardware component of a system to another.

Control Panel A desk accessory that lets you change computer capabilities such as slot assignments, printer connections, network access, and other features.

current startup disk The disk that contains the System files the computer is currently using. The current startup disk icon always appears in the upper-right corner of the Apple IIgs desktop. See *startup disk*.

daisy-chain To connect a series of peripheral devices so that the first device is attached directly to the computer, the second device is attached to the first device, and so on.

desk accessory A "mini-application" that you can use without leaving your main application.

device A computer or peripheral equipment such as a disk drive, printer, or file server.

double-density disk A floppy disk with a storage capacity of 800 kilobytes (K). See *high-density disk*.

drive utility software The software necessary to enable the operating system to communicate with the device.

file Any named, ordered collection of information stored on a disk. Documents, applications, and System files are all files.

Finder The standard application in GS/OS that you use to open applications and documents, and to manage disks, folders, and files.

firmware Programs stored permanently in read-only memory (ROM).

floppy disk A plastic disk with a thin flexible jacket or a hard-shell plastic jacket. See *hard disk*.

floppy disk drive A peripheral device that loads information saved on a disk into the memory of a computer and saves information from the memory of a computer onto a disk. It may be located within the computer's case (internal) or in a case outside of the computer (external).

GS/OS The current operating system for the Apple IIgs. See *ProDOS*.

hard disk A disk permanently sealed into a drive or cartridge. A hard disk can store very large amounts of information compared to a floppy disk. See *floppy disk*.

hardware Those parts of a computer that you can see and touch: the computer, the peripheral devices, the cables used to connect them, and the cords that supply power.

high-density (HD) disks A floppy disk with a storage capacity of 1.4 megabytes (MB). See *double-density disk*.

initialize To prepare a disk to store information and to write a file system on a disk so that an application can locate stored data.

installation The process of adding or changing system software information in the System Folder of a disk.

Installer A program on the Apple IIGS Install disk that lets you add or remove capabilities from your startup disks. For example, if you're connecting a SCSI hard disk, you need to install the SCSI Hard Disk update to your startup disks.

interleave ratio A format for storing and writing information to a disk. The ratio 2:1, for example, corresponds to the number of rotations to data transfers when reading and writing to and from a disk.

port A socket on the back panel of the Apple IIGS for connecting peripheral devices.

ProDOS Acronym for Professional Disk Operating System used on the Apple II computers. ProDOS 8 is the 8-bit version of this operating system that supports the Apple IIe computer. See *GS/OS*.

ProDOS disk format A format for storing and writing information to a disk, so that an application can locate stored data.

SCSI Acronym for Small Computer System Interface, pronounced "SKUH-zee." An industry standard interface that provides high speed access to peripheral devices and allows them to be daisy-chained to a single port or card.

Shift-click To select multiple items by holding down the Shift key while clicking each item.

slot A socket inside the computer into which you can install cards.

Smart Port Another name for the disk drive port. Disk drives connected to the disk drive port appear to be connected to a card in either slot 5 or slot 6, depending on whether they're 3.5-inch drives or 5.25-inch drives. Because the port "knows" what kind of device is connected, it's described as "smart."

software Instructions, usually stored on disks, that tell the computer what to do.

startup disk A disk with all the System files you need to get your computer started. See *current startup disk*.

startup slot On an Apple II computer this is the highest numbered slot containing a startup device such as a drive. In the case of an Apple IIGS, the startup slot can be set manually using the Control Panel.

System file The file that the computer uses to start up and to provide information on added capabilities called updates.

troubleshoot To locate and correct an error, or the cause of a problem or malfunction, in hardware or software.

updates A hardware or software capability you can add to disk by using the Installer.

Index

A

activating expansion slot
text Control Panel 31–33

B

boldface iv
By the way messages v

C

cable connector
Apple IIe 22
Apple IIgs 12
compatibility 28–29
connecting
multiple drives 27
single drive 26
contents of package 3
conventions used in this book iv

D

disk compatibility 28
disk drive malfunction 45
disk types 28

E

expansion slot 44
expansion slot activation
text Control Panel 31–33
expansion slot selection
Apple IIe 16
Apple IIgs 6

F, G

formatting disks 35

H

high-density disks 28

I, J, K, L

identification of high-density disks 29
Important messages v
initializing disks 35, 44
GS/OS 36–37
ProDOS 8 38–40
inserting card
Apple IIe 21
Apple IIgs 11
installation
Apple IIe 18–23
Apple IIgs 8–13
installing floppy drive utility software
33–35
interleave format 37

M

malfunction of drive 45

N

naming rules
ProDOS 36, 40
note messages v

O, P, Q

overview of this product 2

R

removing computer lid
Apple IIe 18
Apple IIgs 8

S, T

selecting expansion slot
Apple IIe 16
Apple IIgs 6
service 46
SuperDrives
special considerations 28
support 46

U, V

UniDisk 3.5 drives
special considerations 30
unrecognized drives 44, 46

W, X, Y, Z

Warning messages iv

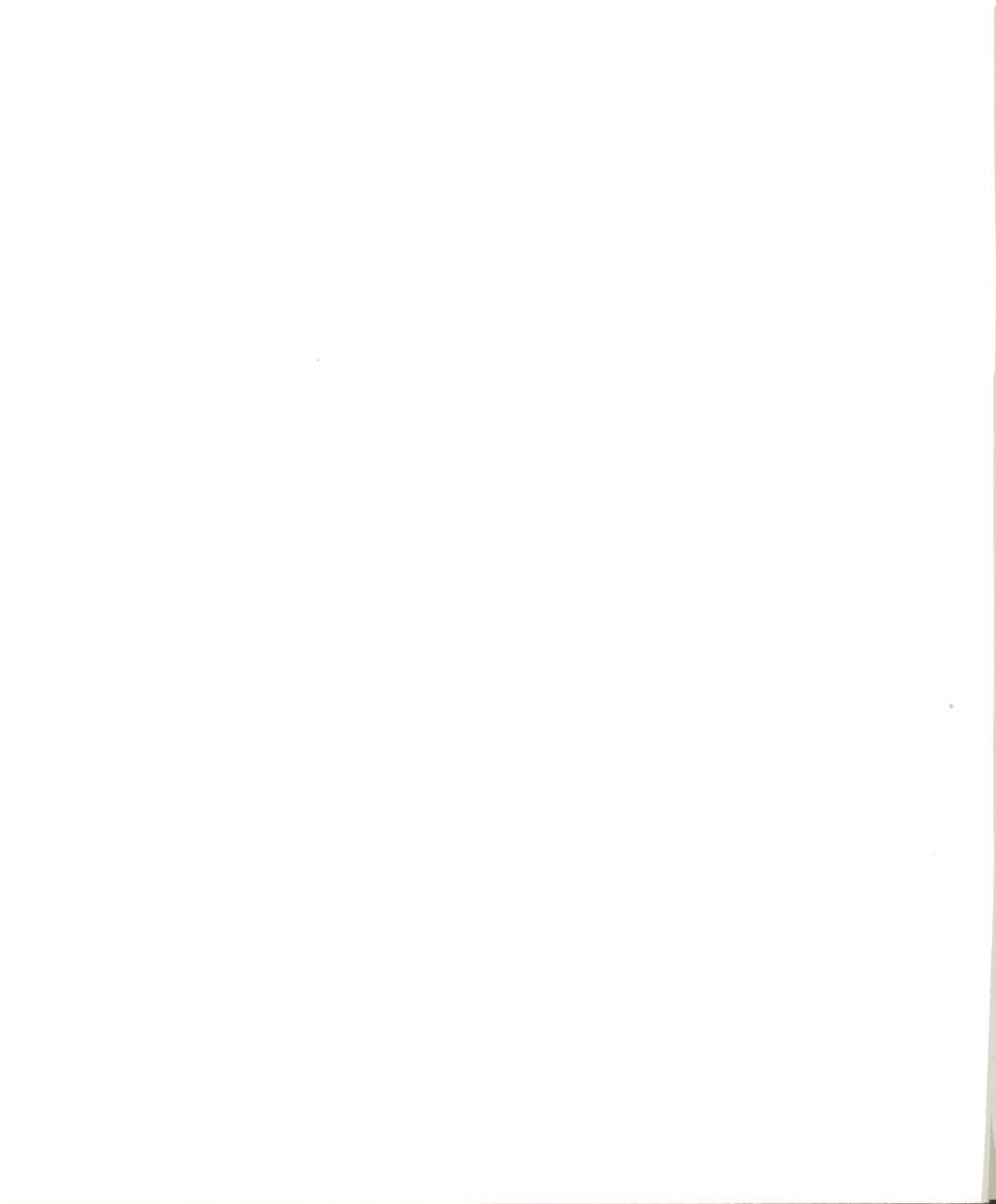

The Apple Publishing System

Apple II 3.5 Disk Controller Card Owner's Guide was written, edited, and composed on a desktop publishing system using Apple® Macintosh® computer, and AppleTalk® network system, Microsoft® Word, and FrameMaker for the Macintosh. Proof pages were created on the Apple LaserWriter® printers. Line art was created using Adobe Illustrator™. PostScript®, the LaserWriter page-description language, was developed by Adobe Systems Incorporated.

Text type and display type are Apple's corporate font, a condensed version of ITC Garamond®. Bullets are ITC Zapf Dingbats®.



Apple Computer, Inc.

20525 Mariani Avenue
Cupertino, CA 95014
(408) 996-1010
TLX 171-576

030-5717-A
Printed in USA